

1 GHz-5 GHz, Bias Tee, SMAf

Caractéristiques électriques <i>Electrical specifications</i>	Conditions de mesures <i>Measurement conditions</i>	Spécifications <i>Specifications</i>			
		Min.	Typ.	Max.	Unités <i>Units</i>
Frequency range	-20 / +55 °C	1		5	GHz
Insertion loss	1-5GHz		0.8	1	dB
Isolation RF to DC	1-5GHz	35	35		dB
VSWR	1-5GHz Input		1.30 :1	1.50 :1	-
VSWR	1-5GHz Output		1.30 :1	1.50 :1	-
RF Power	1-5GHz Input			30	dBm
Voltage	DC port			25	V
Current	DC port			250	mA
Caractéristiques mécaniques <i>Mechanical features</i>	Conditions de mesures <i>Measurement conditions</i>	Spécifications <i>Specifications</i>			
Longueur x largeur x Hauteur <i>Length x width x height</i>	L x W x H ±0.1 mm	33 x 24 x 13 Outline number BTE9			mm
Matière / finition <i>Material / finish</i>	RoHs compliant	Aluminium / Suretec Grey painted			-
Connectique <i>Connectors</i>	DC port	Feedthru			
Connectique <i>Connectors</i>	RF port	2 x SMA f			-
Conditions environnementales <i>Environmental conditions</i>	Conditions de mesures <i>Measurement conditions</i>	Spécifications / Specifications			Unités <i>Units</i>
Température de service <i>Operating temperature</i>		Min.	Typ.	Max.	
		-20		+55	°C
Température de stockage <i>Storage temperature</i>		-45		+85	°C

Ind.	Par	Le	Observation
0	Covasso	25/05/2010	Création

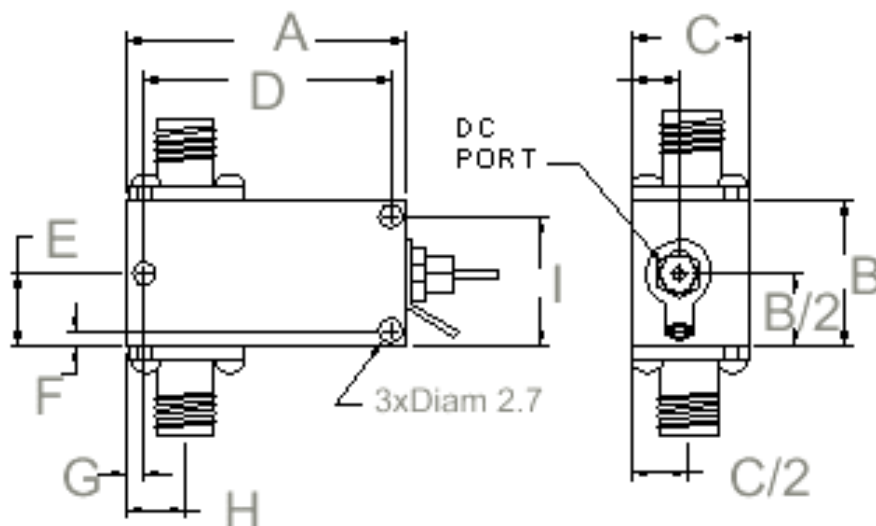

	A	B	C	D	E	F	G	H	I
mm	30.5	16	12.7	26.9	8	1.8	1.8	6.4	14.2

Ind.	Par	Le	Observation
0	Covasso	25/05/2010	Création